

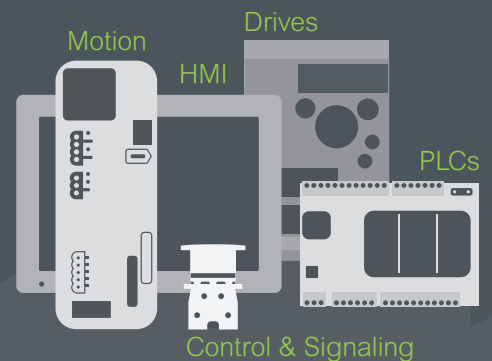

## Introducing the **Easy Series**

Essential automation & control products

*When just enough is just right!*



# Easy Modicon M200

Logic controllers 2-axis motion control,  
for simple machines up to 196 I/O

# Contents

|  |                 |
|--|-----------------|
| <b>Easy Modicon™ M200</b><br>Logic controllers 2-axis motion control, for simple machines up to<br>196 I/O |                 |
| ■ <b>General Presentation</b> .....  | pages 2 to 5    |
| <b>Selection guide</b> .....   | pages 6 and 7   |
| ■ <b>Presentation</b>  |                 |
| □ Main features .....  | page 8          |
| □ Embedded communication .....   | page 9          |
| □ Description .....  | page 9          |
| □ Programming .....  | page 9          |
| □ Options for Easy Modicon M200 logic controllers .....  | page 10         |
| □ I/O expansion with Modicon TM3 expansion modules .....   | page 10         |
| ■ <b>Ethernet Modbus/TCP network</b>   |                 |
| □ Presentation .....   | page 11         |
| □ Transparent Ready class and functions .....  | page 11         |
| ■ <b>References</b>  |                 |
| □ Easy Modicon M200 logic controllers .....  | page 12         |
| □ Cartridges for Easy Modicon M200 logic controllers .....   | page 13         |
| □ Separate parts, replacements parts .....   | page 13         |
| □ Configuration software .....   | page 13         |
| □ Expansion modules .....  | page 13         |
| ■ <b>Compatibility</b>   |                 |
| □ Compatibility with cartridges .....  | pages 14 and 15 |
| □ Compatibility with Modicon TM3 expansion modules .....   | pages 14 and 15 |
| □ Configuration of I/Os .....  | pages 14 and 15 |
| ■ <b>Index</b>   |                 |
| □ Product reference index .....  | page 16         |

## Easy Modicon M200

Logic controllers 2-axis motion control, for simple machines up to 196 I/O

A user-oriented range of products

### Compatibility of offers

#### Easy Modicon M200 logic controllers

- > Modicon TM3 expansion modules
- > TMCR2 cartridge
- > EcoStruxure Machine Expert – Basic software

In the modern industry world, being agile, adaptive and fast responding to the market needs are core values pursued by small and medium machine manufactures. Easy™ Series is the answer to your eager voice.

### A user-oriented range of products

The Easy Modicon M200 range of logic controllers has been designed to meet various customer requirements, specifically on the 3 following key points:

#### Fit for purpose

Designed for simple machines, the particularly small dimensions of Easy Modicon M200 logic controllers are ideal for fitting in wall-mounted and floor-standing control system enclosures.

- Easy Modicon M200 controllers have an embedded Ethernet port (for models with TM200CE●●● references) meaning they can easily be integrated into control system architectures, for remote control and maintenance of machines by means of applications for tablets and PCs.
- The Easy Modicon M200 (TM200C●●●● references) offer provides excellent connection capacity and customization options using I/O or communication cartridges without increasing the controller size or additional wiring.
- Modicon TM3 expansion module offer enhance the digital and analog I/O capacity of Easy Modicon M200 logic controller to a larger scale, thus make possible of more application scenarios.
- The functions embedded in Easy Modicon M200 controllers minimize the cost of the machine: Modbus serial link, USB port dedicated to programming, and simple position control functions (high-speed counters and pulse train outputs with trapezoidal profile and S curve).
- EcoStruxure Machine Expert – Basic programming software is intuitive, making it quick to create applications.

#### Easy throughout the whole life cycle

- Easy to order thanks to the “just enough” number of references
- Easy to mount and wire up
- Easy to set up and program thanks to EcoStruxure Machine Expert – Basic software
- Easy to test and debug thanks to the standard USB port and removable terminal blocks
- Easy to duplicate without special skills using the Micro SD memory card
- Easy to maintain and update with its removable terminal block, USB downloading without mains power, and Micro SD memory card
- Easy to access information by scanning the QRcode carved on the front of the controller, linked to the real-time web database of the dedicated product model, with characteristics, dignostics, maintenance, connections, etc.

#### Robustness

- Inputs designed to help protect against overvoltage
- Transistor outputs monitored to help protect against short-circuits
- DC power supply monitored to help protect against reverse polarity
- Coated electronics for enhanced robustness in polluted environments

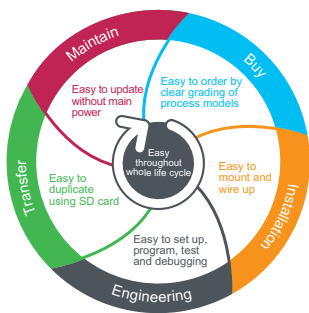
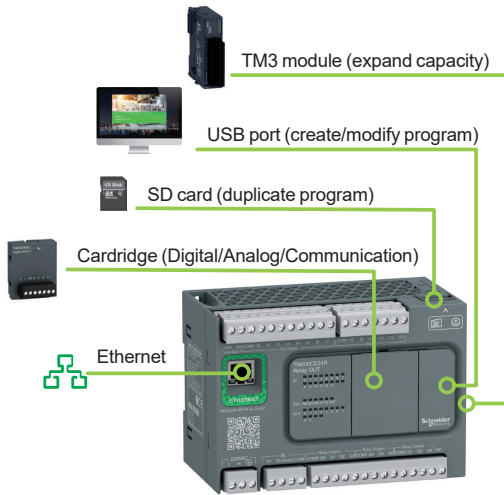

Example: QR coder for TM200C16T

# Easy Modicon M200

Logic controllers 2-axis motion control, for simple machines up to 196 I/O

Applications

## Applications

The right level of flexibility to suit your scalable needs without frills: the range embeds the characteristics that a user might expect of a small PLC; attributes chosen dedicatedly are neat and enough to cover simple machine.

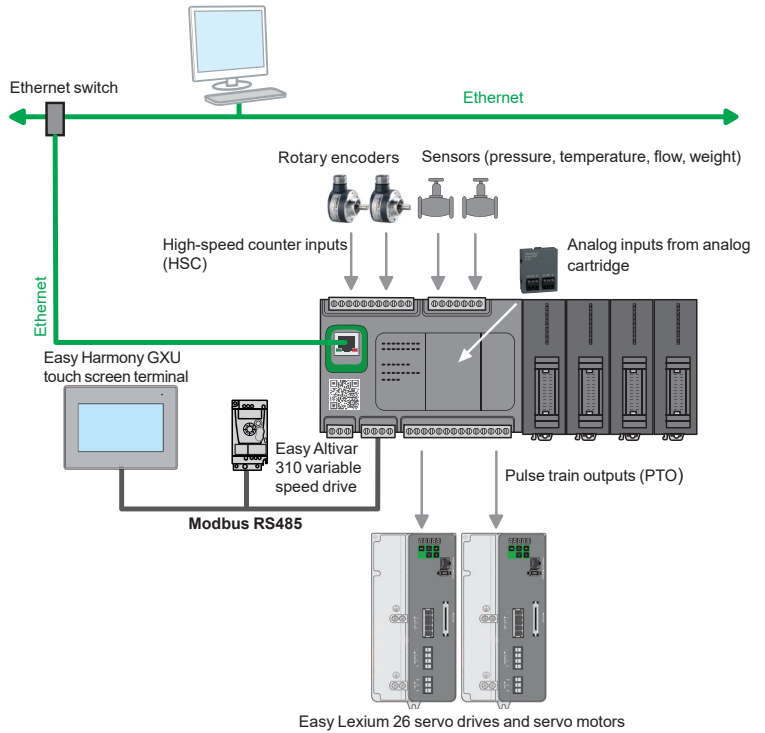

Typical application architecture employing Easy series solution

### Typical applications: repetitive machines

The Easy Modicon M200 logic controller has been designed to be used in the following sectors and for the following repetitive machines:



#### Textiles

- Spinning machine
- Drawing frame
- Carding machine



#### Machine tools

- Grinding machine
- Punching machine
- Draw bench



#### Packaging

- Vertical or horizontal form fill seal machines (VFFS or HFFS)
- Labeling machine



#### HVAC

- Exchange station
- Air cooling system
- Water-cooling screw machine



#### Pumping

- Pumping station
- Pressure filter machine



#### Lift

- Elevator
- Stereo-garage
- Escalator
- Construction lift

# Easy Modicon M200

Logic controllers 2-axis motion control, for simple machines up to 196 I/O

Software

Easy Modicon M200: A user-oriented range of products

Intuitive machine programming with EcoStruxure Machine Expert – Basic

EcoStruxure Machine Expert® is the universal programming software for machines automated by MachineStruxure controllers. Simple navigation that requires only fewer clicks delivers a more efficient engineering process.

- > In order to reduce complexity we offer EcoStruxure Machine Expert – Basic, a simplified engineering tool for the new controller Easy Modicon M200.
- > All programming, visualization, and commissioning are handled in just one intuitive tool that is available as a free download.



EcoStruxure Machine Expert – Basic simplifies every step in the design and commissioning of your machines

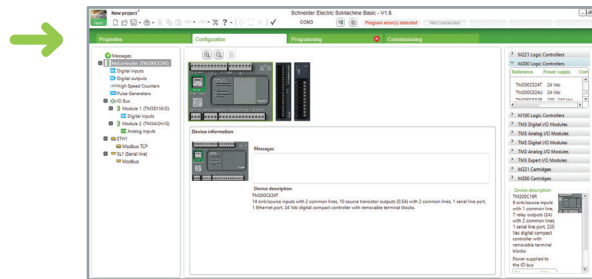

Configuration

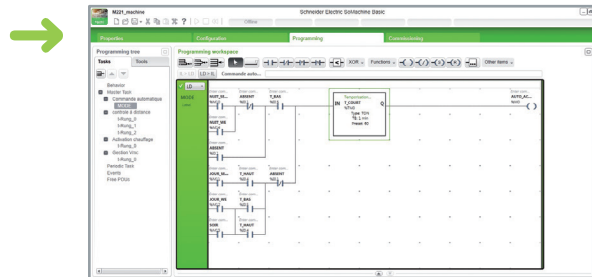

Programming

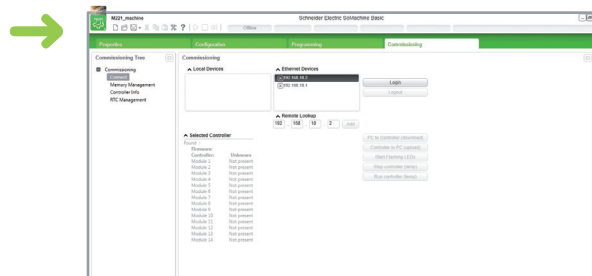

Commissioning

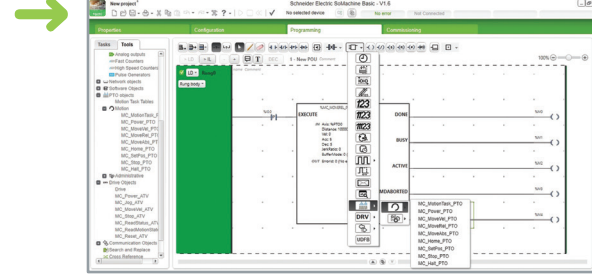

PTO Function Block

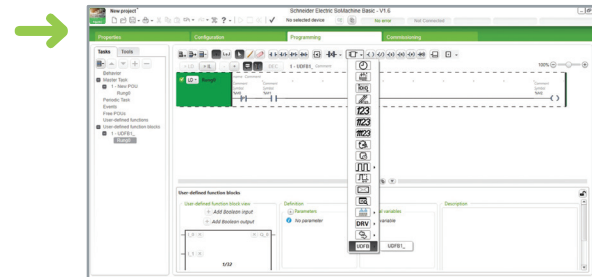

User Defined Function Block



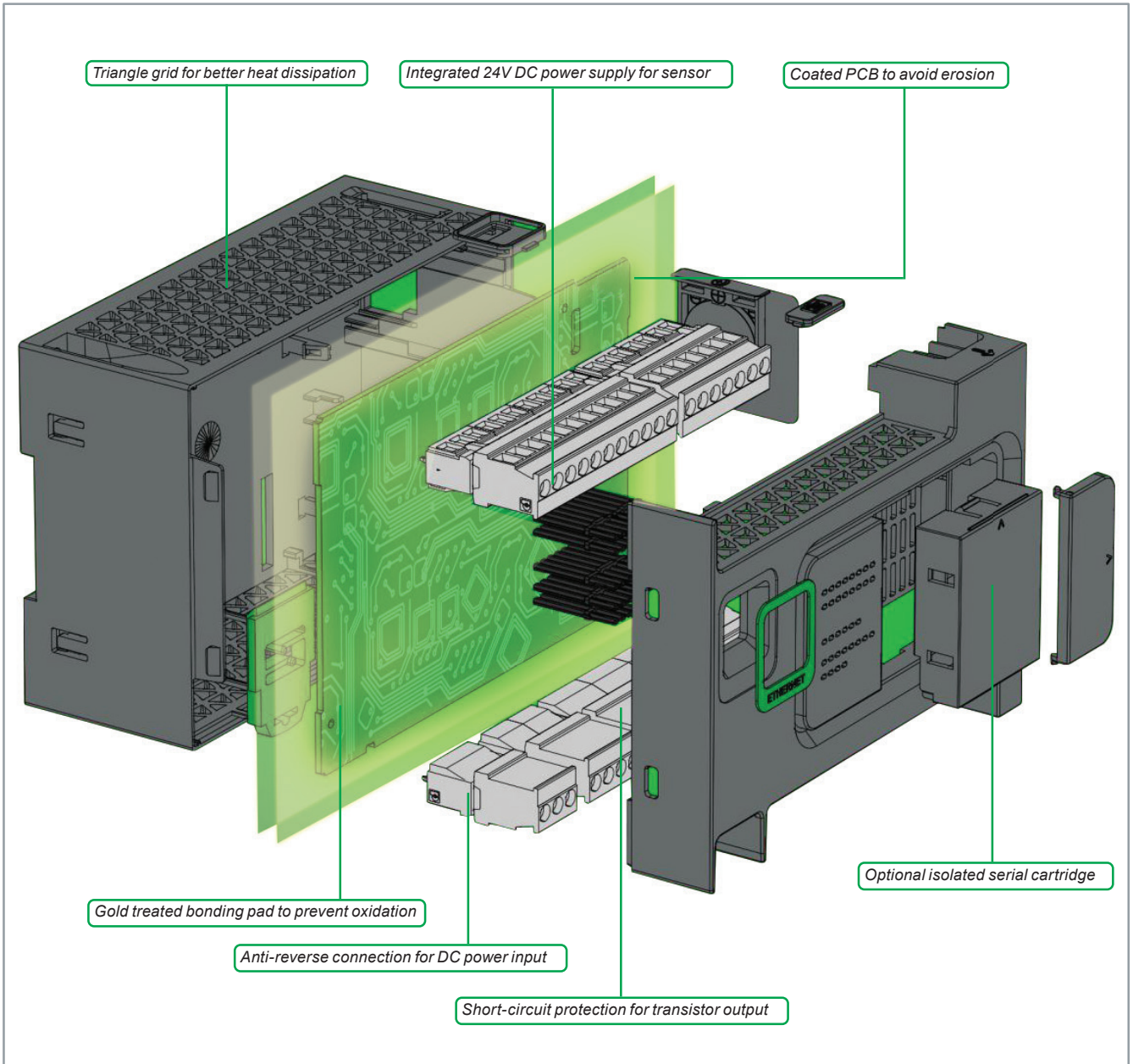



Quality guaranteed to face various challenges in harsh environment



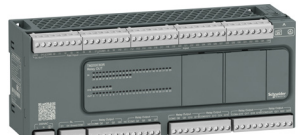

# Easy Modicon M200

Logic controllers 2-axis motion control, for simple machines up to 196 I/O

| Applications  | Control of simple machines   |   |   |   |  |  |   |  |  |   |  |  |   |  |  |  |  |  |
|---|--|---|---|---|--|--|---|--|--|---|--|--|---|--|--|--|--|--|
|   |   |   |   |  |  |  |  |  |  |  |  |  |  |  |  |  |  |  |
| <b>Supply voltage</b>   | 100-240 V ~  | 24 V =  | 24 V =  | 100-240 V ~   | 24 V =   | 24 V =   | 100-240 V ~   | 24 V =   | 24 V =   | 100-240 V ~   | 24 V =   | 24 V =   | 100-240 V ~   |  |  |  |  |  |
| <b>Inputs/outputs</b>   | <b>16 logic I/O</b>  |   |   | <b>24 logic I/O</b>   |  |  | <b>32 logic I/O</b>   |  |  | <b>40 logic I/O</b>   |  |  | <b>60 logic I/O</b>   |  |  |  |  |  |
| <ul style="list-style-type: none"> <li><input checked="" type="checkbox"/> Logic inputs/outputs</li> <li><input type="checkbox"/> No. and type of inputs</li> <li><input type="checkbox"/> No. and type of outputs</li> <li><input type="checkbox"/> Connection of the logic I/O</li> </ul> | 9 sink/source<br>24 V = inputs, inc. 4 high-speed inputs and 4 fast inputs for FC  |   |   | 14 sink/source<br>24 V = inputs, inc. 4 high-speed inputs and 4 fast inputs for FC  |  |  | 20 sink/source<br>24 V = inputs, inc. 4 high-speed inputs and 4 fast inputs for FC  |  |  | 24 sink/source<br>24 V = inputs, inc. 4 high-speed inputs and 4 fast inputs for FC  |  |  | 36 sink/source<br>24 V = inputs, inc. 4 high-speed inputs and 4 fast inputs for FC  |  |  |  |  |  |
|   | 7 relay outputs  | 7 source transistor outputs, including 2 fast outputs | 7 sink transistor outputs, including 2 fast outputs | 10 relay outputs  | 10 source transistor outputs, including 2 fast outputs | 10 sink transistor outputs, including 2 fast outputs | 12 relay outputs  | 12 source transistor outputs, including 2 fast outputs | 12 sink transistor outputs, including 2 fast outputs | 16 relay outputs  | 16 source transistor outputs, including 2 fast outputs | 16 sink transistor outputs, including 4 fast outputs | 24 relay outputs  |  |  |  |  |  |
|   | On removable screw terminal block  |   |   |   |  |  |   |  |  |   |  |  |   |  |  |  |  |  |
| <b>I/O extension</b>  | <ul style="list-style-type: none"> <li><input checked="" type="checkbox"/> 4 Modicon TM3 expansion modules, along with limited number of outputs.</li> </ul>   |   |   |   |  |  |   |  |  |   |  |  |   |  |  |  |  |  |
| Max. number of I/O expansion modules that can be connected  | 132  | 139   | 139   | 132   | 142  | 142  | 132   | 144  | 144  | 132   | 148  | 148  | 132   |  |  |  |  |  |
| Maximum number of transistor outputs  | 71   | 64  | 64  | 74  | 64   | 64   | 76  | 64   | 64   | 80  | 64   | 64   | 88  |  |  |  |  |  |
| Maximum number of relay outputs   |  |   |   |   |  |  |   |  |  |   |  |  |   |  |  |  |  |  |
| <b>Embedded communication</b>   | <ul style="list-style-type: none"> <li><input checked="" type="checkbox"/> Ethernet link</li> <li><input type="checkbox"/> Modbus TCP communication (client &amp; server),</li> <li><input type="checkbox"/> slave Modbus TCP,</li> <li><input type="checkbox"/> DHCP Client dynamic configuration,</li> <li><input type="checkbox"/> Programming, Downloading, Monitoring,</li> <li><input type="checkbox"/> EtherNet/IP adapter</li> </ul> |   |   |   |  |  |   |  |  |   |  |  |   |  |  |  |  |  |
| Serial link   | 1 serial link RS 485 with + 5 V supply   |   |   |   |  |  |   |  |  |   |  |  |   |  |  |  |  |  |
| <b>Embedded functions</b>   | <ul style="list-style-type: none"> <li><input checked="" type="checkbox"/> Process control</li> <li><input type="checkbox"/> Counting</li> <li><input type="checkbox"/> Fast input</li> <li><input type="checkbox"/> Position control</li> </ul>   |   |   |   |  |  |   |  |  |   |  |  |   |  |  |  |  |  |
|   | PID<br>4 high-speed counter inputs (HSC), 100 kHz frequency<br>4 fast inputs for external or interrupt task<br>Position control (PTO), with trapezoidal profile and S curve able to control either: <ul style="list-style-type: none"> <li><input type="checkbox"/> 2 axes in "pulse direction" (P/D) mode</li> <li><input type="checkbox"/> 1 axis in CW/CCW mode</li> </ul> PWM<br>PLS   |   |   |   |  |  |   |  |  |   |  |  |   |  |  |  |  |  |
| <b>Format</b>   | 4 controller sizes: (W x H x D)  |   |   | 110 x 70 x 90 mm<br>4.33 x 2.76 x 3.55 in.  |  |  | 130 x 70 x 90 mm<br>5.12 x 2.76 x 3.55 in.  |  |  | 175 x 70 x 90 mm<br>6.89 x 2.76 x 3.55 in.  |  |  | 175 x 70 x 90 mm<br>6.89 x 2.76 x 3.55 in.  |  |  | 225 x 70 x 90 mm<br>8.86 x 2.76 x 3.55 in. |  |  |
| <b>Options</b>  | <ul style="list-style-type: none"> <li><input checked="" type="checkbox"/> Cartridges</li> <li><input type="checkbox"/> 1 digital I/O expansion cartridge</li> <li><input type="checkbox"/> 5 analog I/O expansion cartridges</li> <li><input type="checkbox"/> 2 additional serial link communication cartridge (1)</li> </ul>  |   |   |   |  |  |   |  |  |   |  |  |   |  |  |  |  |  |
| Number of cartridge slots   | 1  |   |   | 1   |  |  | 2   |  |  | 2   |  |  | 2   |  |  |  |  |  |
| <b>Mounting</b>   | Mounting on  symmetrical rail or panel with specific mounting kit TMAM2   |   |   |   |  |  |   |  |  |   |  |  |   |  |  |  |  |  |
| <b>Software programming</b>   | With EcoStruxure Machine Expert – Basic software (2)   |   |   |   |  |  |   |  |  |   |  |  |   |  |  |  |  |  |
| <b>Logic controller type</b>  | <b>Easy Modicon M200</b>   |   |   |   |  |  |   |  |  |   |  |  |   |  |  |  |  |  |
| Controllers without Ethernet port   | TM200C16R  | TM200C16T   | TM200C16U   | TM200C24R   | TM200C24T  | TM200C24U  | TM200C32R   | TM200C32T  | TM200C32U  | TM200C40R   | TM200C40T  | TM200C40U  | TM200C60R   |  |  |  |  |  |
| Controllers with embedded Ethernet port   | –  | –   | –   | TM200CE24R  | TM200CE24T   | TM200CE24U   | TM200CE32R  | –  | –  | TM200CE40R  | TM200CE40T   | TM200CE40U   | –   |  |  |  |  |  |
| <b>Pages</b>  | 12   |   |   |   |  |  |   |  |  |   |  |  |   |  |  |  |  |  |

(1) Each controller can support 1 communication cartridge maximum.

(2) EcoStruxure Machine Expert – Basic for M100/M200 logic controller could be activated with the special code "ulck8loca" in the software settings. Download this software from global [website](#).

# Easy Modicon M200

Logic controllers 2-axis motion control, for simple machines up to 196 I/O

Main features, Embedded communication

## Main features

### Processing power

- Execution speed: 0.2 μs/Boolean instruction
- Program: 10 K list instructions
- Number of words: 8,000%MW
- Number of internal bits: 1024%M
- Retain memory: 3,000 words (%MW0 to %MW2999)
- Application structure:
  - master task: 1 task configurable as freewheeling or cyclic
  - auxiliary task: 1 task configurable as timer cycle interrupt
  - interrupt task: 4 external tasks tripped by fast inputs and 4 high-speed counters

### Supply characteristics

- Two power supplies are available (depending on the model):  
24 V DC or 100...240 V AC
- Voltage limit (ripple included): 20.4...28.8 V DC/85...264 V AC (50/60Hz)
- Max. consumption:
  - 61-74 VA for AC power supply
  - 18 W for DC power supply

### Connection of the embedded I/O

On removable screw terminal blocks at intervals of 5.08 mm / 0.2 in.; 24 V DC sensor power output provided by the controller (TM200C●●R models only):

- 250 mA for 16 and 24 I/O
- 300 mA for 32, 40 and 60 I/O

### Environmental characteristics

- Degree of protection: IP 20 with protective cover in place
- Ambient operating temperature: 0...55 °C/32...131 °F
- Storage temperature: -25...70 °C/-13...158 °F
- Relative humidity: 5...95% (non-condensing)
- Operating altitude: 0...2,000 m/0...6,560 ft
- Storage altitude: 0...3,000 m/ 0...9,843 ft
- Vibration resistance: IEC/EN 61131-2 panel mounting or mounted on a top hat section rail (DIN rail)

### Product certification and conformity to standards

- CE certification
- Conformity to the main national and international standards concerning electronic industrial control devices (IEC/EN 61131-2, UL 508, and IEC/EN 61010-2-201)

## Embedded communication

M200 logic controllers have 3 types of integrated communication port:

- Ethernet (depending on the model)
- RS 485 embedded serial link
- Mini-USB programming port

### Communication on Ethernet network

TM200CE●●● controllers have an embedded RJ 45 Ethernet port (10/100 Mbps, MDI/MDIX) with Modbus TCP (8 servers/1 client).

As well as the default address based on the MAC address, a controller IP address can be assigned via a DHCP server or via a BOOTP server.

- The Ethernet port also offers application uploading, updating, and debugging functions when the controller is supplied with power.
- The integrity of applications is maintained by cybersecurity functions.
- A firewall allows each communication protocol to be locked.

### Serial links

Each TM200C●●● controller has an embedded RS 485 serial link. This serial link also provides the functionality for loading, updating and development when the controller is powered up. The two main commercially-available protocols are embedded in this link:

- Modbus ASCII/RTU Master or Slave
- Character string (ASCII)



## Description

# Easy Modicon M200

Logic controllers 2-axis motion control, for simple machines up to 196 I/O

Description, Programming

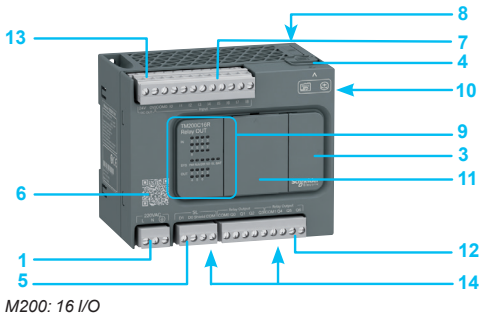

M200: 16 I/O

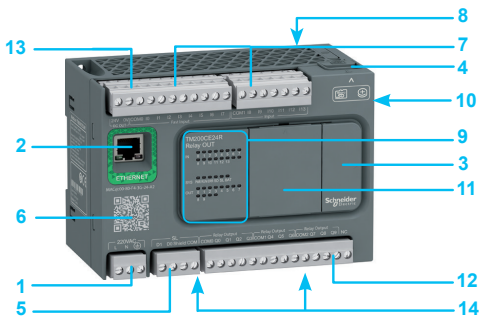

M200: 24 I/O and Ethernet port

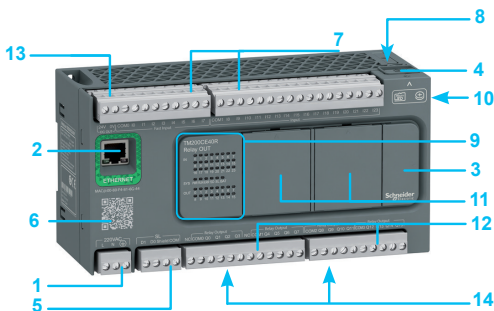

M200: 32 I/O and Ethernet port

M200: 40 I/O and Ethernet port

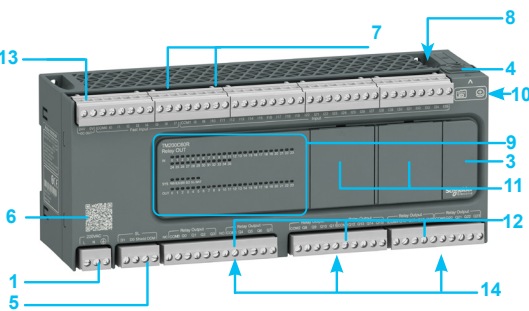

M200: 60 I/O port



Consult catalog ref [DIA3ED2181201EN](#)

## Description

### M200 logic controllers (TM200C●●●)

- 1 Removable screw terminal block, 3 terminals for connecting the 24 V DC or the 100...240 V AC power supply (depending on the model)
- 2 On TM200CE●●● controllers: RJ45 connector for Ethernet network, with exchange rate and activity LED
- 3 Behind the removable cover:
  - USB mini-B connector for connecting a PC equipped with the EcoStruxure Machine Expert – Basic software
  - Run/Stop switch
- 4 Slot for Micro SD memory card
- 5 Serial link (RS 485): connector on removable screw terminal block
- 6 Controller technical documentation QR code
- 7 Connection of 24 V DC digital inputs on removable screw terminal blocks (1)
- 8 On top of the controller: slot for RTC battery
- 9 LED display block showing:
  - the status of the controller and its components (battery, Micro SD memory card)
  - serial link status
  - I/O status
- 10 On the side of the controller: TM3 bus connector for the link with a Modicon TM3 expansion module
- 11 Slot(s) for I/O cartridge(s) or communication cartridge:
  - one on M200 controllers with 16 and 24 I/O
  - two on M200 controllers with 32, 40 and 60 I/O
- 12 Connection of relay or transistor (depending on the model) digital outputs: on removable screw terminal blocks (2)
- 13 Sensor power supply 24 V DC output (TM200CE●●R or TM200C●●R models only)
- 14 Clip for locking on 35 mm/1.38 in. DIN rail

## Programming

Easy Modicon M200 controllers are programmed with EcoStruxure Machine Expert – Basic software (3).

### EcoStruxure Machine Expert – Basic software

EcoStruxure Machine Expert – Basic programming software is a neat tool designed to develop projects on Easy Modicon M200 and Easy Modicon M100 logic controllers. It offers a modern interface, and programming with power off charging function. So that getting started is user-friendly, fast and convenient:

- Simplified interface helps you find the information you need in two or three clicks maximum
- Engineering process is efficient due to the functions available, including the FB (Function Block) and UDFB (User-Defined Function Block)
- Ability to upload an application program or the firmware without the controller being powered by another source

EcoStruxure Machine Expert – Basic software runs on the following configurations:

- Microsoft Windows® 7 Professional Edition 32-bit and 64-bit, Microsoft Windows® 8 Professional Edition 32-bit and 64-bit, Microsoft Windows® 8.1 32-bit and 64-bit, Microsoft Windows® 10
- 1 GHz Premium processor, 1 GB hard disk, and 1 GB RAM minimum
- Recommended minimum screen resolution of 1280 x 800 pixels

(1) Number of digital inputs according to model: see next page.

(2) Number of digital outputs according to model: see next page.

(3) Available as a free download from our [website](#) and accessible with serial number "ulck8loca".

# Easy Modicon M200

Logic controllers 2-axis motion control, for simple machines up to 196 I/O

Options, I/O expansion modules

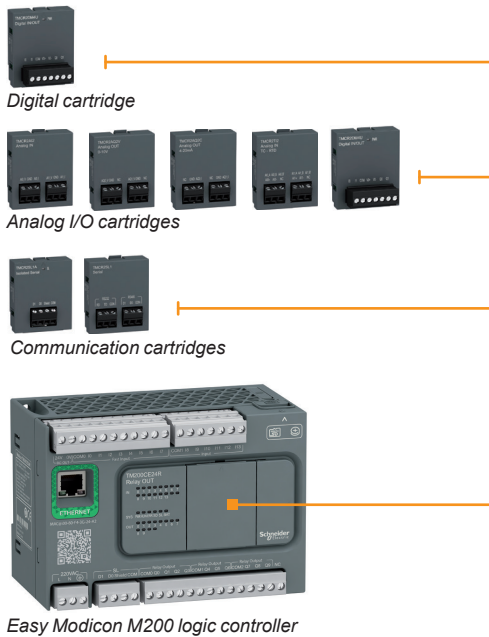

Easy Modicon M200 logic controller



- 1 Easy Modicon M200 logic controller
- 2 Modicon TM3 digital I/O modules
- 3 Modicon TM3 analog I/O modules (1)

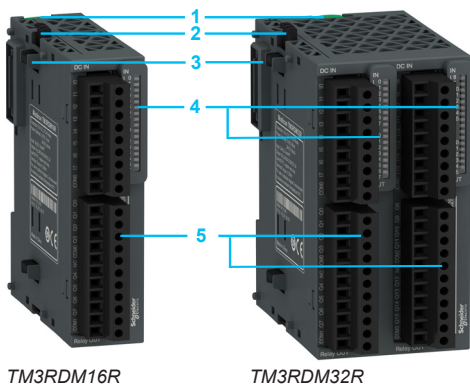

TM3RDM16R

TM3RDM32R

## Options for Easy Modicon M200 logic controllers

### Cartridges

Depending on the controller size, one or two cartridges can be inserted on the front of Easy Modicon M200 controllers without increasing the dimensions:

- 1 cartridge for controllers with 16 and 24 I/O
  - 2 cartridges for controllers with 32, 40 and 60 I/O
- 3 types of cartridges are offered:
- Digital I/O cartridges
    - **TMCR2DM4U** for 2 digital inputs and 2 transistor sink outputs
  - Analog I/O cartridges
    - **TMCR2AI2** for 2 analog inputs that can be configured as voltage or current
    - **TMCR2TI2** for 2 temperature inputs
    - **TMCR2AQ2V** for 2 voltage analog outputs
    - **TMCR2AQ2C** for 2 current analog outputs
    - **TMCR2AM3** for 2 analog inputs and 1 analog output
  - Communication cartridges
    - **TMCR2SL1** cartridge providing additional serial port terminals for connection of a printer, barcode reader, etc.
    - **TMCR2SL1A** cartridge providing additional isolated serial link
    - Each controller can support one TMCR2SL1 or TMCR2SL1A serial link maximum.

## I/O expansion with Modicon TM3 expansion modules

### Modicon TM3 expansion modules

The capacity of M200 logic controllers can be enhanced with the Modicon TM3 expansion module offer:

- Digital I/O modules can be used to create configurations with up to 196 digital I/O. These modules are available with the same connections as the controllers.
- Analog I/O modules can be used to create configurations with up to 32 analog I/O and are designed to receive, amongst other things, position, temperature, and speed sensor signals. They are also capable of controlling variable speed drives or any other device equipped with a current or voltage input.

For more information, please refer to Modicon TM3 catalog ref. [DIA3ED2140109EN](#) or consult Modicon TM3 offer on our global [website](#).

### Modicon TM3R digital I/O modules

Modicon TM3R digital I/O modules, consist of 2 types of mixed input/output modules, are specially designed and only applicable for Modicon M200 logic controller.

- 1 Clip for locking on symmetrical rail.
- 2 Adjacent module locking catch.
- 3 TM3 bus connectors (one on each side to provide continuity of the link between connected modules).
- 4 LED display block for the module channels and diagnostics.
- 5 Input or output channel terminal blocks.

| Number of logic I/O | inputs                        | Number and type of outputs | References |
|---------------------|-------------------------------|----------------------------|------------|
| 16 inputs/outputs   | 8 sink/source 24 V DC inputs  | 8 relay outputs, 2 A       | TM3RDM16R  |
| 32 inputs/outputs   | 16 sink/source 24 V DC inputs | 16 relay outputs, 2 A      | TM3RDM32R  |

(1) Depending on type of Modicon TM3 module used, see page 14

# Easy Modicon M200

Logic controllers 2-axis motion control, for simple machines up to 196 I/O

Ethernet Modbus/TCP network



Easy Modicon M200 logic controller

## Presentation

Easy Modicon M200 controllers can easily be integrated in typical architectures:

- **machine to devices** (variable speed drives, remote I/O modules, operator dialog terminals) with the I/O Scanner function
  - **machine to supervision** with the Modbus Client/Server function
- Ethernet also brings transparency to the factory, in particular - thanks to the firewall functions - making it possible from any point on the network to:
- program or monitor a controller, or download an application
  - access device parameters (variable speed drives for example)

## The Modbus/TCP protocol

Modbus has been the industry communication standard since 1979. During the internet revolution, Modbus was combined with Ethernet Modbus/TCP to form Modbus/TCP, a completely open Ethernet protocol. The development of a connection to Modbus/TCP does not require any proprietary component, nor the purchase of a licence.

This protocol can easily be combined with any product supporting a standard Modbus/TCP communication stack.

### Modbus/TCP, simple and open

- The Modbus application layer is simple and universally familiar with its 9 million installed connections.
- Thousands of manufacturers have already implemented this protocol. Many have already developed a Modbus/TCP connection and numerous products are currently available.
- The simplicity of Modbus/TCP enables any fieldbus device, such as an I/O module, to communicate on Ethernet without the need for a powerful microprocessor or a lot of internal memory.

### Modbus/TCP, high performance

Thanks to the simplicity of its protocol and fast speed of 100 Mbps, the performance of Modbus/TCP is excellent. This type of network can therefore be used in realtime applications such as I/O digitization.

### Modbus/TCP, a standard

- The application protocol is identical on Modbus serial link and Modbus/TCP: messages can be routed from one network to the other without converting the protocol.
- Since Modbus operates on the TCP higher layer, users benefit from IP routing, thus enabling devices located anywhere in the world to communicate without worrying about the distance between them.

Modbus and Modbus/TCP are recognized as a fieldbus by the international standard IEC/EN 61158. They also comply with the Chinese national standard managed by ITEI.

## Transparent Ready class and functions

|                                      | TM200CE●●● Logic controllers |
|--------------------------------------|------------------------------|
| Transparent Ready class              | A10                          |
| Internet protocol version            | IP V4                        |
| <b>Ethernet services</b>             |                              |
| Programming, downloading, monitoring |                              |
| Client and server Modbus TCP         |                              |
| Slave Modbus TCP                     |                              |
| Client DHCP dynamic configuration    |                              |

Function created

# Easy Modicon M200

Logic controllers 2-axis motion control, for simple machines up to 196 I/O



TM200C16R



TM200CE24R



TM200CE32R



TM200C40R



TM200C60R



TM200C16U



TM200C24U



TM200C32U



TM200C40U



TM200CE40T

## Easy Modicon M200 logic controllers (1)

| Number of digital I/O              | W x H x D (mm/in.)                   | Digital inputs   | Digital outputs   | Embedded communication ports (2) |             | Reference  | Weight<br>kg<br>lb |
|------------------------------------|--------------------------------------|--|---|----------------------------------|-------------|------------|--------------------|
|                                    |                                      |  |   | Ethernet (RJ 45)                 | Serial link |            |                    |
| <b>100...240 V AC power supply</b> |                                      |  |   |                                  |             |            |                    |
| 16 I/O                             | 110 x 70 x 90/<br>4.33 x 2.76 x 3.55 | 9 sink/source 24 V DC inputs inc. 1 regular input, 4 high-speed inputs for HSC, 4 fast inputs for FC       | 7 relay outputs   | –                                | 1           | TM200C16R  | 0.359<br>0.791     |
| 24 I/O                             | 130 x 70 x 90/<br>5.12 x 2.76 x 3.55 | 14 sink/source 24 V DC inputs inc. 6 regular inputs, 4 high-speed inputs for HSC, and 4 fast inputs for FC | 10 relay outputs  | –                                | 1           | TM200C24R  | 0.405<br>0.893     |
|                                    |                                      |  |   | 1                                | 1           | TM200CE24R | 0.413<br>0.911     |
| 32 I/O                             | 175 x 70 x 90/<br>6.89 x 2.76 x 3.55 | 20 sink/source 24 V DC inputs inc. 12 regular inputs, 4 high-speed inputs for HSC, 4 fast inputs for FC    | 12 relay outputs  | –                                | 1           | TM200C32R  | 0.504<br>1.111     |
|                                    |                                      |  |   | 1                                | 1           | TM200CE32R | 0.512<br>1.129     |
| 40 I/O                             | 175 x 70 x 90/<br>6.89 x 2.76 x 3.55 | 24 sink/source 24 V DC inputs inc. 16 regular inputs, 4 high-speed inputs for HSC, 4 fast inputs for FC    | 16 relay outputs  | –                                | 1           | TM200C40R  | 0.504<br>1.111     |
|                                    |                                      |  |   | 1                                | 1           | TM200CE40R | 0.512<br>1.129     |
| 60 I/O                             | 225 x 70 x 90/<br>8.86 x 2.76 x 3.55 | 36 sink/source 24 V DC inputs inc. 28 regular inputs, 4 high-speed inputs for HSC, 4 fast inputs for FC    | 24 relay outputs  | –                                | 1           | TM200C60R  | 0.700<br>1.543     |
| <b>24 V DC power supply</b>        |                                      |  |   |                                  |             |            |                    |
| 16 I/O                             | 110 x 70 x 90/<br>4.33 x 2.76 x 3.55 | 9 sink/source 24 V DC inputs inc. 1 regular input, 4 high-speed inputs for HSC, 4 fast inputs for FC       | 7 sink outputs inc. 5 regular transistor outputs, 2 fast outputs (PWM/PLS/PTO)      | –                                | 1           | TM200C16U  | 0.339<br>0.747     |
|                                    |                                      |  | 7 source outputs inc. 5 regular transistor outputs, 2 fast outputs (PWM/PLS/PTO)    | –                                | 1           | TM200C16T  | 0.365<br>0.805     |
| 24 I/O                             | 130 x 70 x 90/<br>5.12 x 2.76 x 3.55 | 14 sink/source 24 V DC inputs inc. 6 regular inputs, 4 high-speed inputs for HSC, 4 fast inputs for FC     | 10 sink outputs inc. 8 regular transistor outputs, 2 fast outputs (PWM/PLS/PTO)     | –                                | 1           | TM200C24U  | 0.382<br>0.842     |
|                                    |                                      |  | 10 source outputs, inc. 8 regular transistor outputs, 2 fast outputs (PWM/PLS/PTO)  | –                                | 1           | TM200C24T  | 0.416<br>0.917     |
| 32 I/O                             | 175 x 70 x 90/<br>6.89 x 2.76 x 3.55 | 20 sink/source 24 V DC inputs inc. 4 high-speed inputs, 4 fast inputs for FC                               | 12 sink transistor outputs inc. 2 high-speed outputs (PWM/PLS/PTO)                  | 1                                | 1           | TM200C32U  | 0.468<br>1.032     |
|                                    |                                      |  | 12 source transistor outputs, inc. 2 fast outputs (PWM/PLS/PTO)                     | 1                                | 1           | TM200C32T  | 0.522<br>1.151     |
| 40 I/O                             | 175 x 70 x 90/<br>6.89 x 2.76 x 3.55 | 24 sink/source 24 V DC inputs, inc. 16 regular inputs, 4 high-speed inputs for HSC, 4 fast inputs for FC   | 16 sink outputs inc. 14 regular transistor outputs, 2 fast outputs (PWM/PLS/PTO)    | –                                | 1           | TM200C40U  | 0.468<br>1.032     |
|                                    |                                      |  | 16 source outputs, inc. 14 regular transistor outputs, 2 fast outputs (PWM/PLS/PTO) | 1                                | 1           | TM200CE40U | 0.483<br>1.065     |
|                                    |                                      |  |   | –                                | 1           | TM200C40T  | 0.522<br>1.151     |
|                                    |                                      |  |   | 1                                | 1           | TM200CE40T | 0.523<br>1.153     |

(1) Easy Modicon M200 controllers are supplied with:  
 - removable screw terminal blocks for connecting the I/O  
 - a removable screw terminal block for connecting the power supply  
 - a removable screw terminal block for the serial link

(2) Each Easy Modicon M200 logic controller has an embedded USB mini-B programming port.



# Easy Modicon M200

Logic controllers 2-axis motion control, for simple machines up to 196 I/O



## Options for Easy Modicon M200 logic controllers (1)

| Description                     | Details   | Unit reference   | Weight<br>kg<br>lb |
|---------------------------------|---|------------------|--------------------|
| <b>Digital I/O cartridges</b>   | 2 digital inputs<br>2 transistor sink outputs<br>Connection via screw terminal block  | <b>TMCR2DM4U</b> | 0.023<br>0.051     |
| <b>Analog I/O cartridges</b>    | 2 analog inputs (12-bit resolution) configurable as:<br>- 0...10 V voltage<br>- 0...20 mA/4...20 mA current<br>Connection via screw terminal block  | <b>TMCR2AI2</b>  | 0.025<br>0.055     |
|                                 | 2 analog inputs (12-bit resolution)<br>0...10V/ 0...5V/ 0...20mA/ 4...20mA<br>1 analog output (12-bit resolution)<br>0...10V/ 0...5V/ 0...20mA/ 4...20mA<br>Connection via screw terminal block | <b>TMCR2AM3</b>  | 0.024<br>0.053     |
|                                 | 2 temperature inputs (12 or 14-bit resolution depending on input signal) type K, J, R, S, B, E, T, N, C, PT100, PT1000, NI100, NI1000<br>Connection via screw terminal block                    | <b>TMCR2TI2</b>  | 0.025<br>0.055     |
|                                 | 2 analog outputs (12-bit resolution) 0...10 V voltage<br>Connection via screw terminal block  | <b>TMCR2AQ2V</b> | 0.025<br>0.055     |
|                                 | 2 analog outputs (12-bit resolution) 4...20 mA current<br>Connection via screw terminal block   | <b>TMCR2AQ2C</b> | 0.025<br>0.055     |
| <b>Communication cartridges</b> | 1 additional RS485 serial link on screw terminal block  | <b>TMCR2SL1</b>  | 0.025<br>0.055     |
|                                 | 1 additional isolated RS485 serial link on screw terminal block   | <b>TMCR2SL1A</b> | 0.014<br>0.031     |

## Separate parts for Easy Modicon M200 logic controllers

| Description            | Details                 | Sold in lots of | Unit reference   | Weight<br>kg<br>lb |
|------------------------|-------------------------|-----------------|------------------|--------------------|
| <b>Cartridge cover</b> | Allows IP 20 protection | 4               | <b>TMARCOVER</b> | –                  |
| <b>RTC battery</b>     | –                       | 1               | <b>TMARBAT1</b>  | –                  |



TMARCOVER

## Replacements parts for Easy Modicon M200 logic controllers

| Description  | Details  | Sold in lots of | Unit reference | Weight<br>kg<br>lb |
|--|--|-----------------|----------------|--------------------|
| <b>Set of terminal blocks for connecting the I/O on M200 controllers</b> | 3-way terminal block for power supply connection | 5               | <b>TMARTB3</b> | –                  |
|  | 4-way terminal block for serial link connection  | 5               | <b>TMARTB4</b> | –                  |



TMARTB3

## Programming software

| Designation                               | For use with   | Reference   |
|---|--|---|
| <b>EcoStruxure Machine Expert – Basic</b> | Easy Modicon M200 logic controllers.<br>PC should be equipped with Windows 10 or Windows 7 or 8 (32-bit or 64-bit) | Download this software from our <a href="#">website</a> |

## Expansion modules

| Description                          | For use with                        | Reference  |
|--------------------------------------|-------------------------------------|--|
| <b>Modicon TM3 expansion modules</b> | Easy Modicon M200 logic controllers | See our list of compatible expansion modules on pages 14 and 15, or refer to refer to Modicon TM3 catalog ref. <a href="#">DIA3ED2140109EN</a> |

(1) One cartridge for controllers with 16 and 24 I/O. Two cartridges maximum for controllers with 32, 40 and 60 I/O, only one of which can be a communication cartridge.

# Easy Modicon M200

Logic controllers 2-axis motion control, for simple machines up to 196 I/O

Product compatibility, Configuration limits

| Compatibility         |           |   | Easy modicon M200 logic controller |           |           |            |            |            |            |           |           |            |            |            |           |
|-----------------------|-----------|---|------------------------------------|-----------|-----------|------------|------------|------------|------------|-----------|-----------|------------|------------|------------|-----------|
| Cartridge             |           |   | TM200C16R                          | TM200C16U | TM200C16T | TM200C24R  | TM200C24U  | TM200C24T  | TM200C32R  | TM200C32U | TM200C32T | TM200C40R  | TM200C40U  | TM200C40T  | TM200C60R |
| Type                  | Reference | Number and type of I/O                              |                                    |           |           | TM200CE24R | TM200CE24U | TM200CE24T | TM200CE32R |           |           | TM200CE40R | TM200CE40U | TM200CE40T |           |
| Digital I/O cartridge | TMCR2DM4U | 2 digital inputs + 2 transistor sink outputs        |                                    |           |           |            |            |            |            |           |           |            |            |            |           |
| Analog I/O cartridge  | TMCR2AI2  | 2 voltage/current inputs                            |                                    |           |           |            |            |            |            |           |           |            |            |            |           |
|                       | TMCR2AM3  | 2 voltage/current inputs + 1 voltage/current output |                                    |           |           |            |            |            |            |           |           |            |            |            |           |
|                       | TMCR2TI2  | 2 temperature inputs                                |                                    |           |           |            |            |            |            |           |           |            |            |            |           |
|                       | TMCR2AQ2V | 2 voltage outputs                                   |                                    |           |           |            |            |            |            |           |           |            |            |            |           |
|                       | TMCR2AQ2C | 2 current outputs                                   |                                    |           |           |            |            |            |            |           |           |            |            |            |           |
|                       | TMCR2SL1  | 1 RS485 serial link                                 |                                    |           |           |            |            |            |            |           |           |            |            |            |           |
|                       | TMCR2SL1A | 1 isolated RS485 serial link                        |                                    |           |           |            |            |            |            |           |           |            |            |            |           |

Possible to insert 2 cartridges  
 Possible to insert 1 cartridge

| Modicon TM3 expansion modules |           |   | Easy modicon M200 logic controller |           |           |            |            |            |            |           |           |            |            |            |           |
|-------------------------------|-----------|---|------------------------------------|-----------|-----------|------------|------------|------------|------------|-----------|-----------|------------|------------|------------|-----------|
| Type                          | Reference | Number and type of I/O  | TM200C16R                          | TM200C16U | TM200C16T | TM200C24R  | TM200C24U  | TM200C24T  | TM200C32R  | TM200C32U | TM200C32T | TM200C40R  | TM200C40U  | TM200C40T  | TM200C60R |
|                               |           |   |                                    |           |           | TM200CE24R | TM200CE24U | TM200CE24T | TM200CE32R |           |           | TM200CE40R | TM200CE40U | TM200CE40T |           |
| Digital module                | TM3DI8    | 8 x 24 V ∴ sink/source inputs                                       |                                    |           |           |            |            |            |            |           |           |            |            |            |           |
|                               | TM3DI16   | 16 x 24 V ∴ sink/source inputs                                      |                                    |           |           |            |            |            |            |           |           |            |            |            |           |
|                               | TM3DI32K  | 32 x 24 V ∴ sink/source inputs                                      |                                    |           |           |            |            |            |            |           |           |            |            |            |           |
|                               | TM3DQ8R   | 8 x 24 V ∴ /240 V a relay outputs                                   |                                    |           |           |            |            |            |            |           |           |            |            |            |           |
|                               | TM3DQ8T   | 8 x 24 V ∴ source transistor outputs                                |                                    |           |           |            |            |            |            |           |           |            |            |            |           |
|                               | TM3DQ8U   | 8 x 24 V ∴ sink transistor outputs                                  |                                    |           |           |            |            |            |            |           |           |            |            |            |           |
|                               | TM3DQ16R  | 16 x 24 V ∴ /240 V ∼ relay outputs                                  |                                    |           |           |            |            |            |            |           |           |            |            |            |           |
|                               | TM3DQ16T  | 16 x 24 V ∴ source transistor outputs                               |                                    |           |           |            |            |            |            |           |           |            |            |            |           |
|                               | TM3DQ16U  | 16 x 24 V ∴ sink transistor outputs                                 |                                    |           |           |            |            |            |            |           |           |            |            |            |           |
|                               | TM3DQ32TK | 32 x 24 V ∴ source transistor outputs                               |                                    |           |           |            |            |            |            |           |           |            |            |            |           |
|                               | TM3DQ32UK | 32 x 24 V ∴ sink transistor outputs                                 |                                    |           |           |            |            |            |            |           |           |            |            |            |           |
|                               | TM3DM8R   | 4 x 24 V ∴ sink/source inputs + 4 x 24 V ∴ /240 V ∼ relay outputs   |                                    |           |           |            |            |            |            |           |           |            |            |            |           |
|                               | TM3DM24R  | 16 x 24 V ∴ sink/source inputs + 8 x 24 V ∴ /240 V ∼ relay outputs  |                                    |           |           |            |            |            |            |           |           |            |            |            |           |
|                               | TM3RDM16R | 8 x 24 V ∴ sink/source inputs + 8 x 24 V ∴ /240 V ∼ relay outputs   |                                    |           |           |            |            |            |            |           |           |            |            |            |           |
|                               | TM3RDM32R | 16 x 24 V ∴ sink/source inputs + 16 x 24 V ∴ /240 V ∼ relay outputs |                                    |           |           |            |            |            |            |           |           |            |            |            |           |
| Analog module                 | TM3AI2H   | 2 voltage/current inputs  |                                    |           |           |            |            |            |            |           |           |            |            |            |           |
|                               | TM3AI4    | 4 voltage/current inputs  |                                    |           |           |            |            |            |            |           |           |            |            |            |           |
|                               | TM3TI4    | 4 voltage/current or temperature inputs                             |                                    |           |           |            |            |            |            |           |           |            |            |            |           |
|                               | TM3AI8    | 8 voltage/current inputs  |                                    |           |           |            |            |            |            |           |           |            |            |            |           |
|                               | TM3TI8T   | 8 temperature inputs  |                                    |           |           |            |            |            |            |           |           |            |            |            |           |
|                               | TM3AQ2    | 2 voltage/current outputs   |                                    |           |           |            |            |            |            |           |           |            |            |            |           |
|                               | TM3AQ4    | 4 voltage/current outputs   |                                    |           |           |            |            |            |            |           |           |            |            |            |           |
|                               | TM3TM3    | 2 voltage/current or temperature inputs + 1 voltage/current outputs |                                    |           |           |            |            |            |            |           |           |            |            |            |           |
|                               | TM3AM6    | 4 voltage/current inputs + 2 voltage/current outputs                |                                    |           |           |            |            |            |            |           |           |            |            |            |           |

Possible to combine, up to 4 modules

## Configuration of I/O modules

Modicon TM3 digital I/O modules connect to Easy Modicon M200 logic controllers with a maximum of 4 local I/O modules. The maximum number of Modicon TM3 expansion modules can be reduced by the number of transistor outputs or relay outputs used (see the table below).

| Configuration limits  | Easy modicon M200 logic controller |           |           |            |            |            |            |           |           |            |            |            |           |
|---|------------------------------------|-----------|-----------|------------|------------|------------|------------|-----------|-----------|------------|------------|------------|-----------|
|   | TM200C16R                          | TM200C16U | TM200C16T | TM200C24R  | TM200C24U  | TM200C24T  | TM200C32R  | TM200C32U | TM200C32T | TM200C40R  | TM200C40U  | TM200C40T  | TM200C60R |
|   |                                    |           |           | TM200CE24R | TM200CE24U | TM200CE24T | TM200CE32R |           |           | TM200CE40R | TM200CE40U | TM200CE40T |           |
| Maximum number of transistor outputs directly connected to the logic controller | 132                                | 139       | 139       | 132        | 142        | 142        | 132        | 144       | 144       | 132        | 148        | 148        | 132       |
| Maximum number of relay outputs directly connected to the logic controller      | 71                                 | 64        | 64        | 74         | 64         | 64         | 76         | 64        | 64        | 80         | 64         | 64         | 88        |

For more information on TM3 expansion modules, please visit Schneider Electric global website [www.schneider-electric.com](http://www.schneider-electric.com)



---

| T          |    |
|------------|----|
| TM200C16R  | 12 |
| TM200C16T  | 12 |
| TM200C16U  | 12 |
| TM200C24R  | 12 |
| TM200C24T  | 12 |
| TM200C24U  | 12 |
| TM200C32R  | 12 |
| TM200C32T  | 12 |
| TM200C32U  | 12 |
| TM200C40R  | 12 |
| TM200C40T  | 12 |
| TM200C40U  | 12 |
| TM200C60R  | 12 |
| TM200CE24R | 12 |
| TM200CE24T | 12 |
| TM200CE24U | 12 |
| TM200CE32R | 12 |
| TM200CE40R | 12 |
| TM200CE40T | 12 |
| TM200CE40U | 12 |
| TM3RDM16R  | 10 |
| TM3RDM32R  | 10 |
| TMARBAT1   | 13 |
| TMARCOVER  | 13 |
| TMARTB3    | 13 |
| TMARTB4    | 13 |
| TMCR2AI2   | 13 |
| TMCR2AM3   | 13 |
| TMCR2AQ2C  | 13 |
| TMCR2AQ2V  | 13 |
| TMCR2DM4U  | 13 |
| TMCR2SL1   | 13 |
| TMCR2SL1A  | 13 |
| TMCR2TI2   | 13 |

Life Is On



Learn more about our products at  
[www.schneider-electric.com](http://www.schneider-electric.com)

The information provided in this documentation contains general descriptions and/or technical characteristics of the performance of the products contained herein. This documentation is not intended as a substitute for and is not to be used for determining suitability or reliability of these products for specific user applications. It is the duty of any such user or integrator to perform the appropriate and complete risk analysis, evaluation and testing of the products with respect to the relevant specific application or use thereof. Neither Schneider Electric nor any of its affiliates or subsidiaries shall be responsible or liable for misuse of the information contained herein.

Design: Schneider Electric  
Photos: Schneider Electric

**Schneider Electric Industries SAS**

Head Office  
35, rue Joseph Monier - CS 30323  
F-92500 Rueil-Malmaison Cedex  
France

DIA3ED2140906EN  
November 2020 - V6.1